

03/07/2018

*District 2*

**MP**



**DC**



**Peabody** Office

**Kimball**® Office

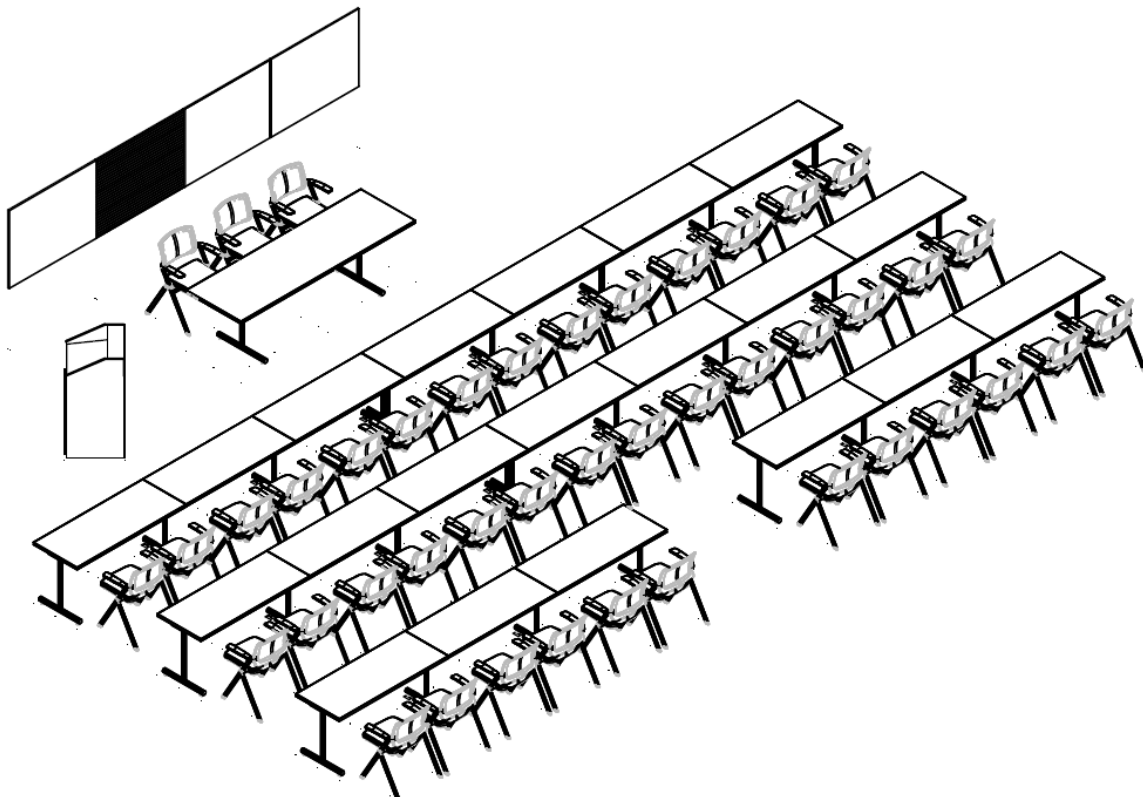
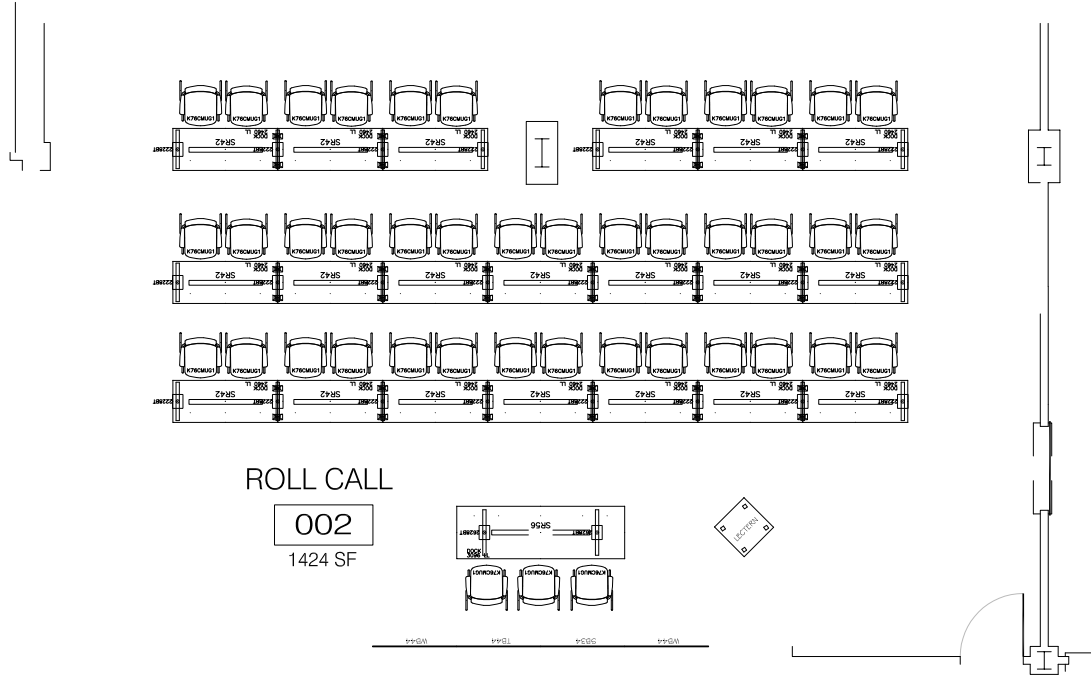



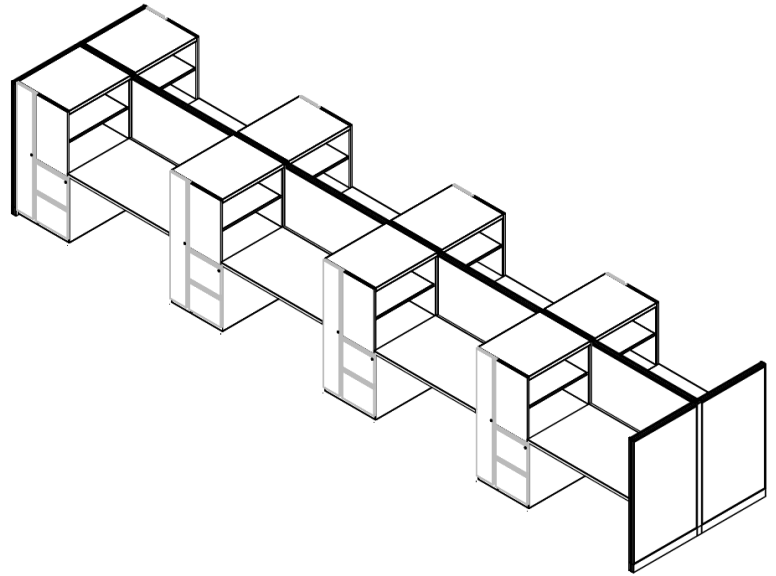
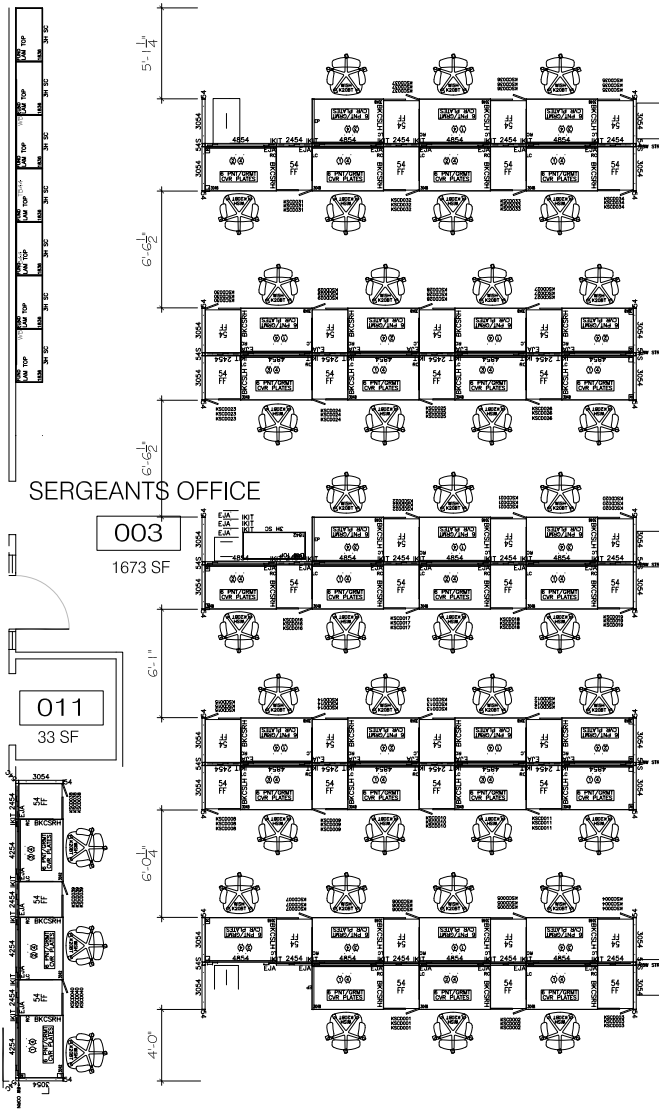





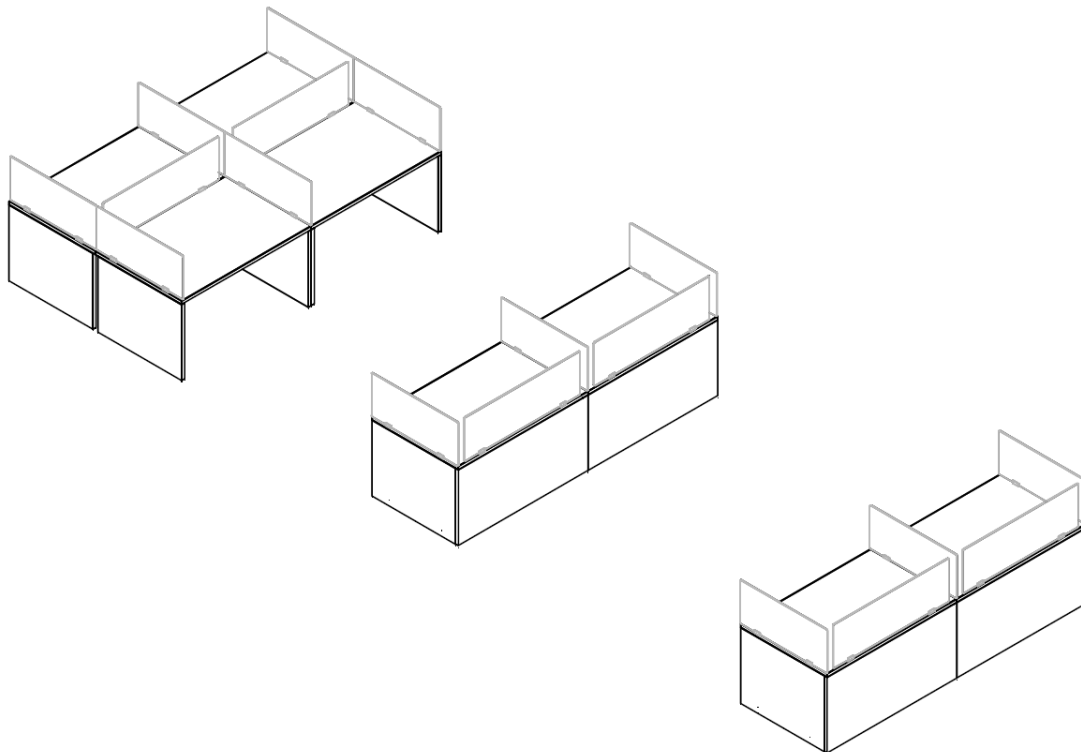
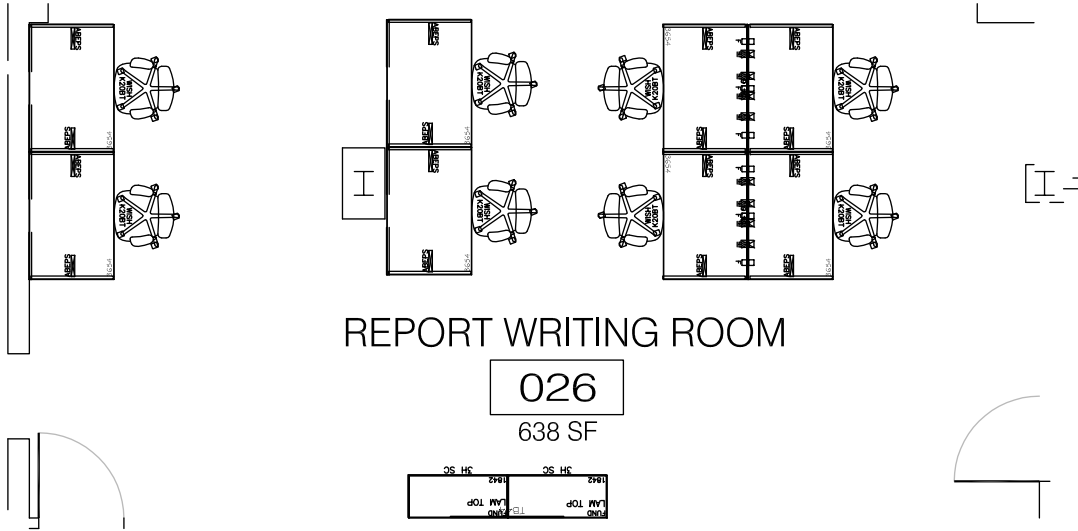



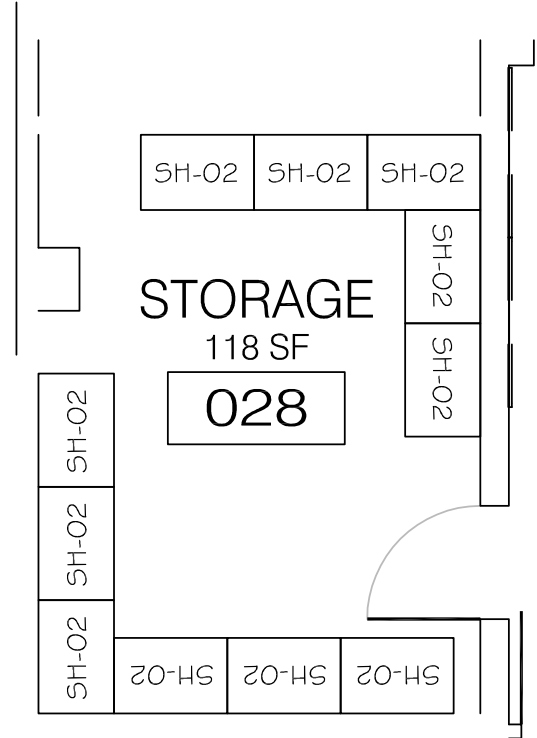
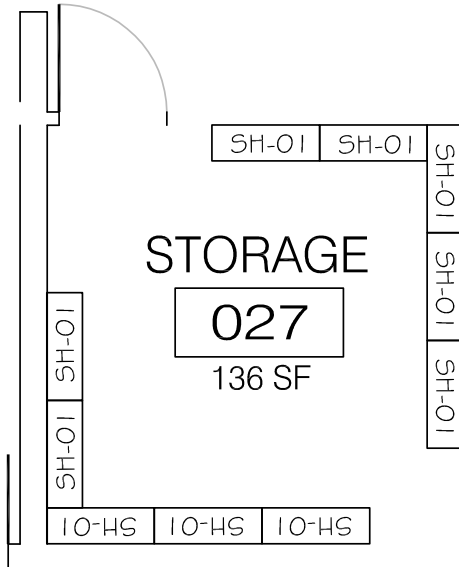

H-5520 Uline Shelving  
36"x12"x84"



H-5187 Uline Shelving  
36"x24"x84"





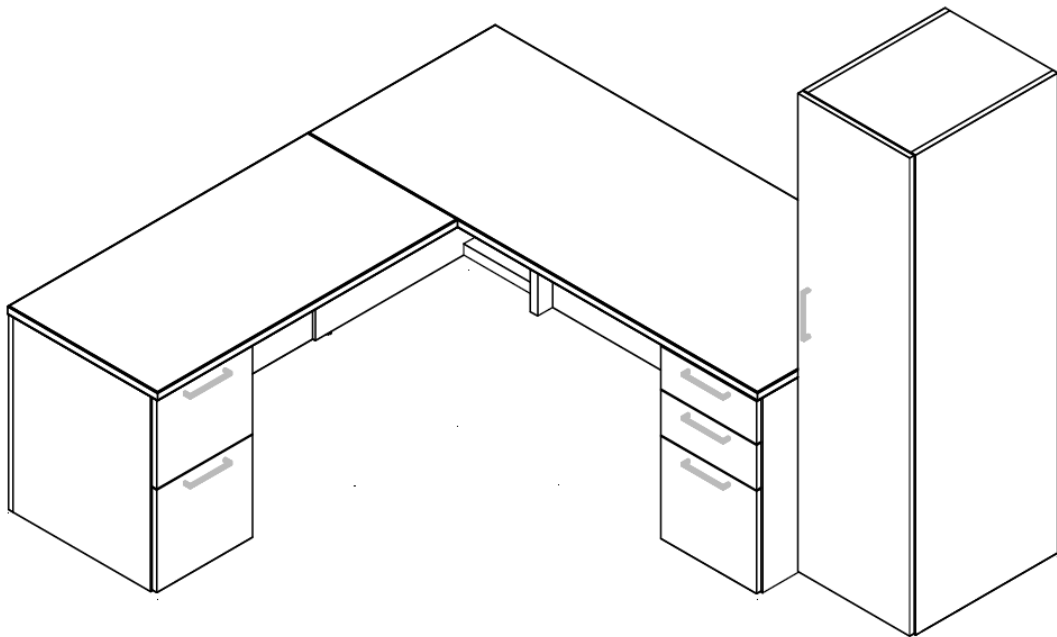
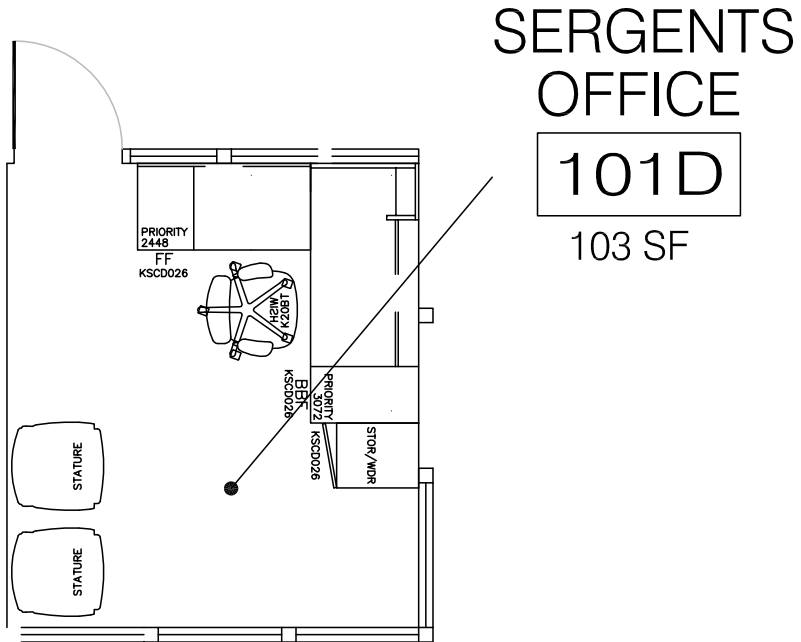



SERGEANTS OFFICE  
101D RENDERING

Peabody Office

BOSTON • DC • CONNECTICUT  
[www.peabodyoffice.com](http://www.peabodyoffice.com)

2000 M St. NW, Ste. 507  
Washington, DC 20036  
T: 202.450.6398



Kimball®Office



COMMUNITY ROOM  
112  
RENDERING



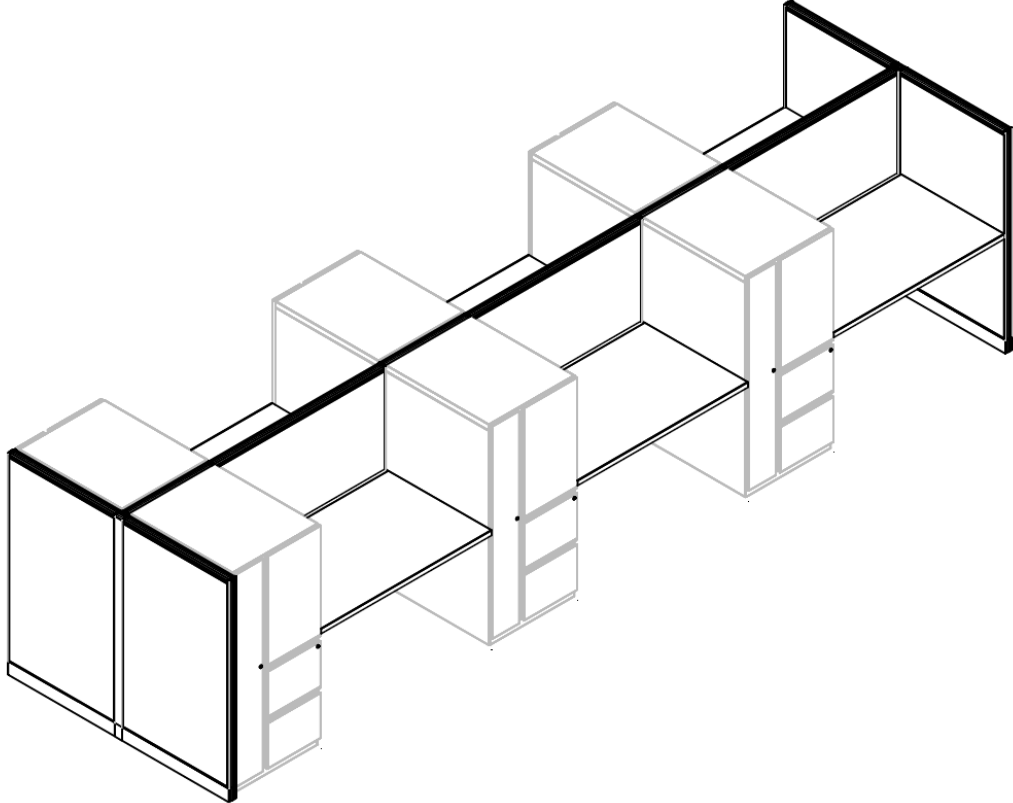
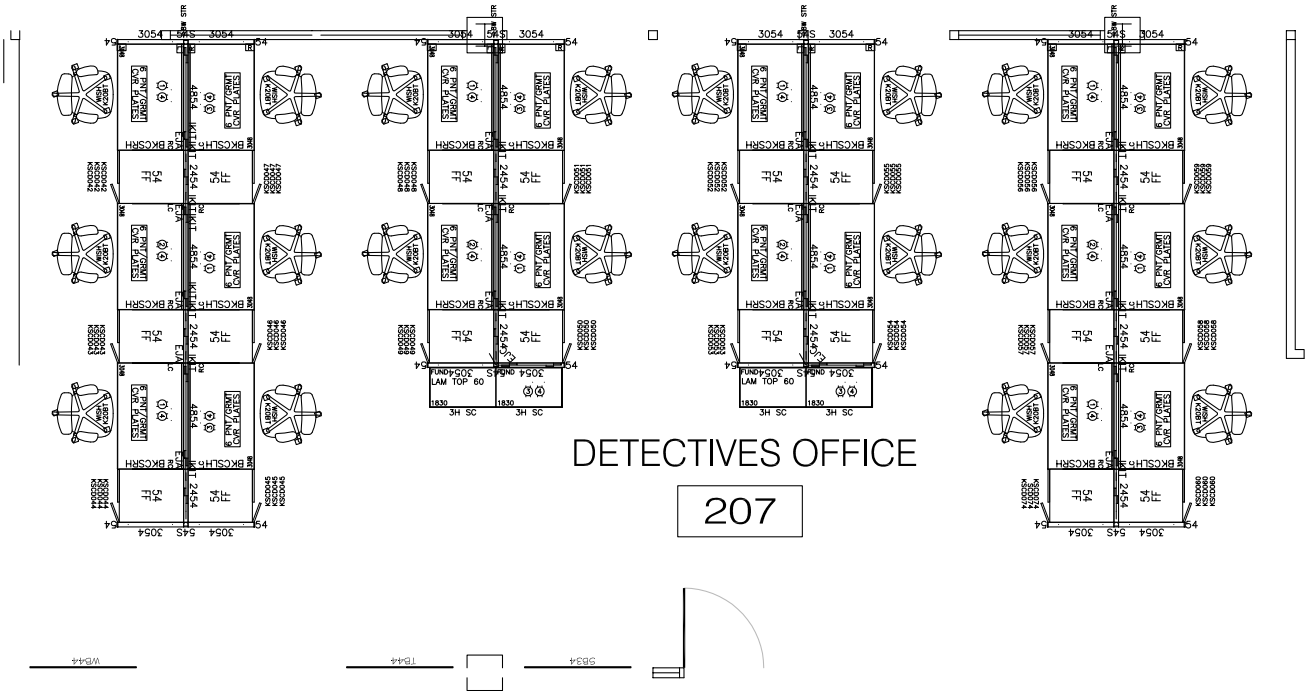



DETECTIVES OFFICE  
207  
RENDERING



CONFERENCE  
ROOM  
209

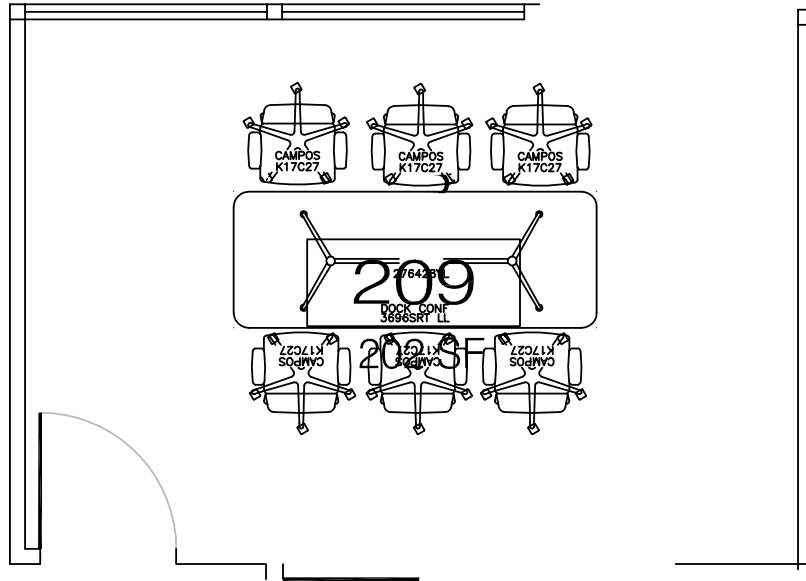

CONFERENCE  
ROOM  
209  
RENDERING



SERGEANT/CRIME  
ANALYSIS ROOM  
210

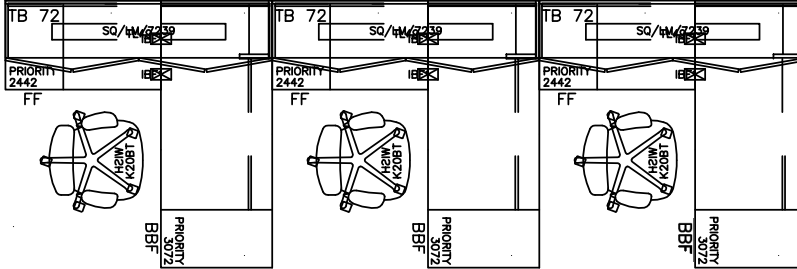

SERGEAT/CRIM  
ANALYSIS  
OFFICE  
210  
276 SF

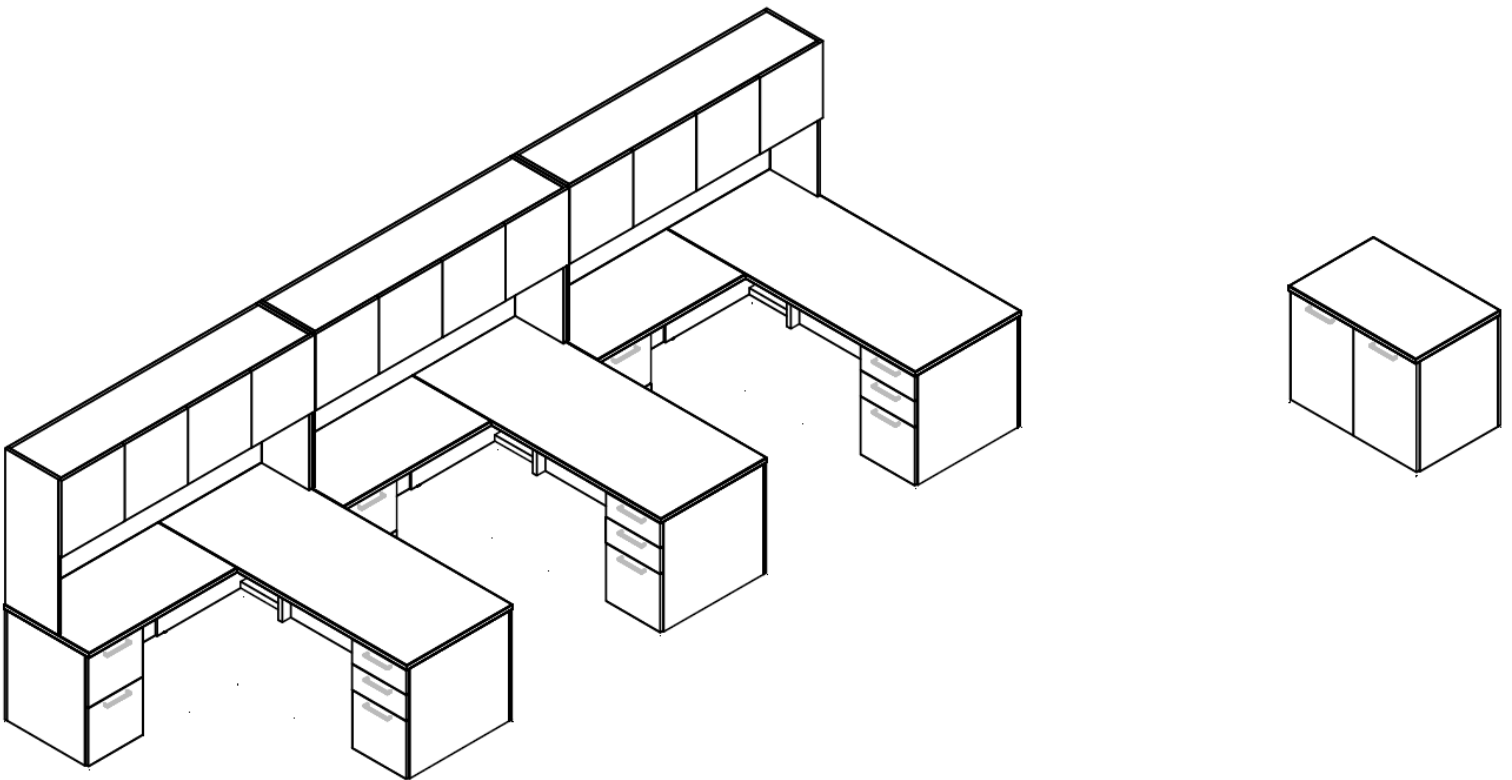
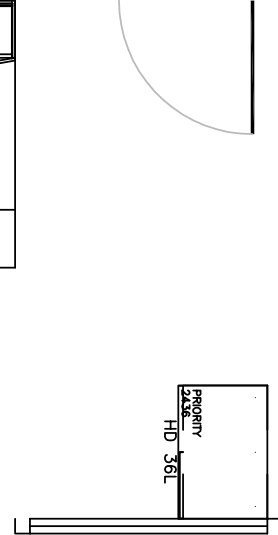



SERGEANT/CRIME  
ANALYSIS ROOM  
210  
RENDERING

Peabody Office

BOSTON • DC • CONNECTICUT  
[www.peabodyoffice.com](http://www.peabodyoffice.com)

2000 M St. NW, Ste. 507  
Washington, DC 20036  
T: 202.450.6398



Kimball°Office



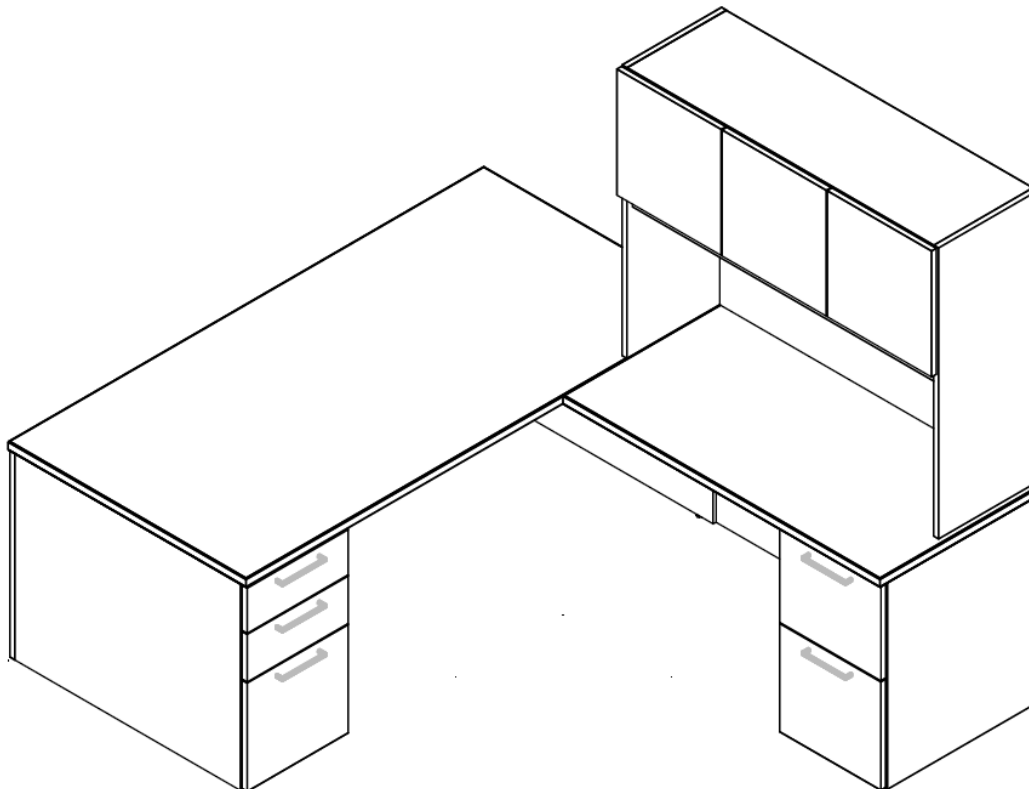
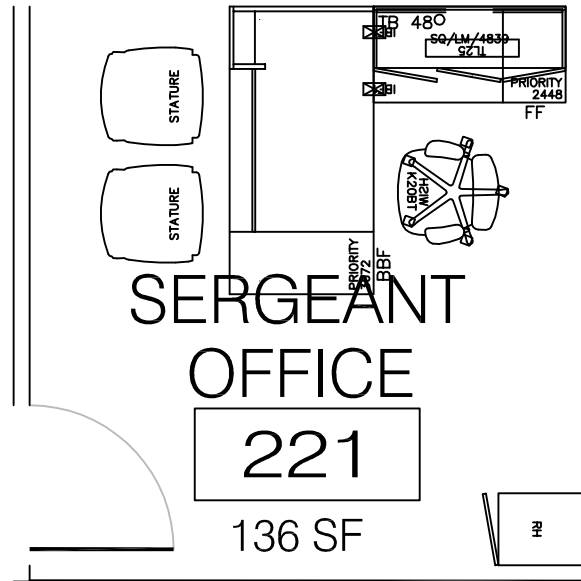



TYPICAL  
PRIVATE  
OFFICE  
RENDERING

**Peabody Office**

BOSTON • DC • CONNECTICUT  
[www.peabodyoffice.com](http://www.peabodyoffice.com)

2000 M St. NW, Ste. 507  
Washington, DC 20036  
T: 202.450.6398



Kimball°Office





LIEUTENANTS OFFICE  
241  
RENDERING

**Peabody Office**

BOSTON • DC • CONNECTICUT  
[www.peabodyoffice.com](http://www.peabodyoffice.com)

2000 M St. NW, Ste. 507  
Washington, DC 20036  
T: 202.450.6398



Kimball°Office

# ALL Finishes

**Tack Board Fabric**  
**Crossroads Pewter**

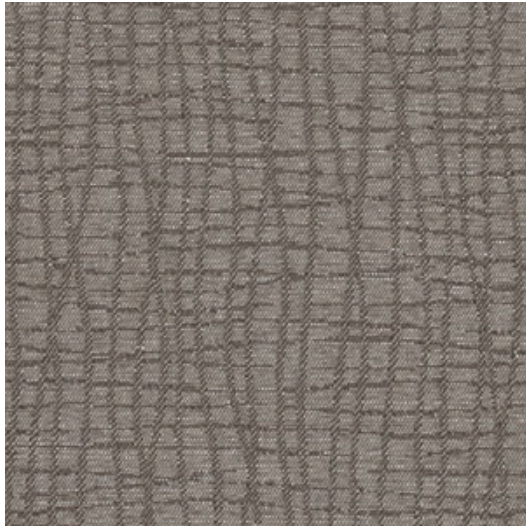

**Paint**  
**Storm**



**Laminate**  
**Amber Cherry**





6'x4' White Boards  
4'x4' White Boards



## 4'x4' Tack Boards 1111 Smoke Cork



3'x4' Scheduling Boards  
1113 Gray Cork  
2 Door / locking



# Kimball®Office

## WISH Task Seating



- Height-adjustable arms with fixed cap or 3D arm caps (front-to-back, side-to-side and pivot).
- Loop arms and armless models.
- 3 seat-height options, including low seat height option and stools.
- Height-adjustable lumbar.
- Multi-position back lock with anti-kickback feature.
- Variety of fabrics and leathers.
- Six-zone tensioning and pneumatic height adjustment.
- Meets ANSI/BFMA standards.

---

**Task Seating Fabric  
Twilight Vapor**

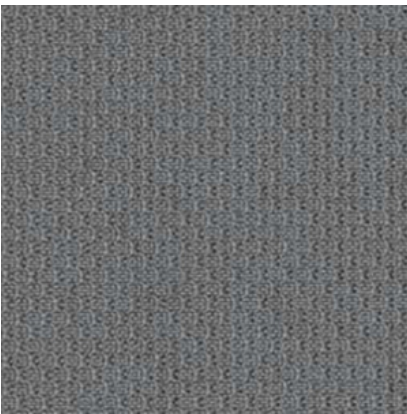

**Lieutenants Task Seating Fabric  
Twilight Cinder 23116**



# Kimball®Office

## CAMPOS Conference Rm 209 Seating



**Mesh Back  
Black**



**Seat Fabric  
Spectrum Black**

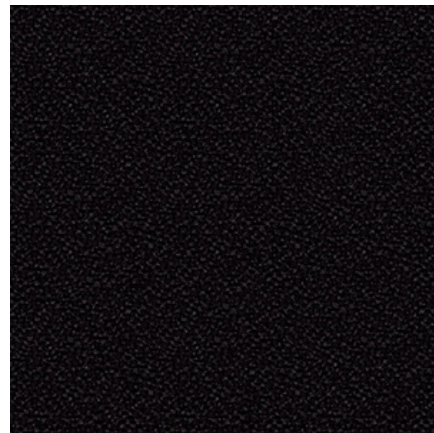

**Kimball® Office**  
**STATURE Guest**  
**Seating**

**PRIVATE OFFICE GUEST SEATING**



**Fabric**  
**Spectrum Black 20020**





# Kimball®Office FLIP Seating

## ROLL CALL SEATING



**Dolce Black,  
Seat Fabric**



# Kimball®Office POLY Seating

## COMMUNITY ROOM SEATING



**Poly Color:  
Charcoal**

