



# BEAR MOUNTAIN SECURITY

SECURITY | DESIGN | INNOVATION

## *Bear Grille Deco Mesh Fence*

The most attractive and decorative range of Deco Fencing Products available on the market. Bear Mountain's Range of Deco Fencing Solutions are available in a range of mesh types and gauges, colors, heights and can be provided with our unique Bear Grip Self-Locking Posts which eliminate the traditional assembly methods of fencing products. Bear Mountain's Deco Fencing Products can be assembled without the need to use any mechanical fasteners to connect the panel to the post. Another very unique feature is our Solar Light Post Cap which can illuminate the fence line without having to install any electrical infrastructure whatsoever!

### **3D MODELING**

Bear Mountain's Designers can provide interactive 3D modeling and design to meet your site's unique requirements.

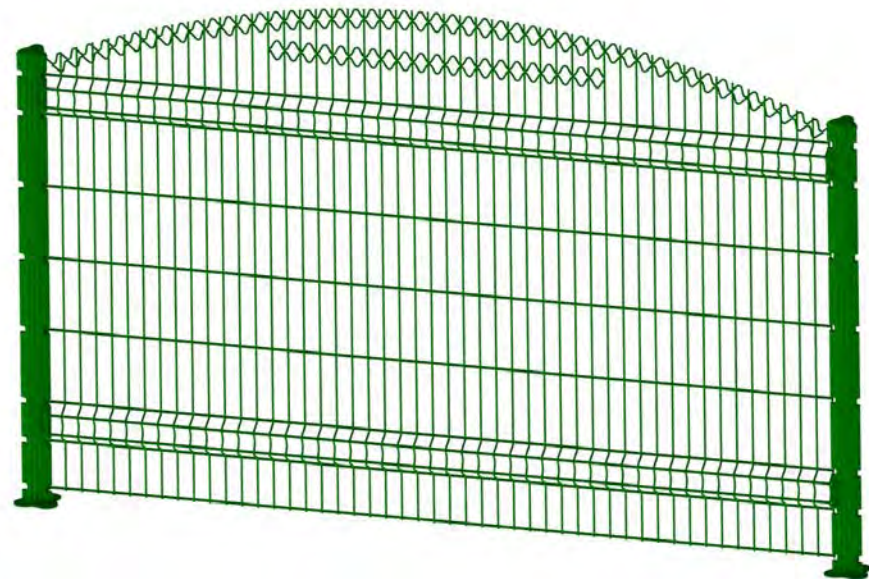





### CUSTOM SOLUTIONS

Developed, designed and engineered to meet your site specific requirements. Bear Mountain offers a multitude of mesh dimensions, wire gauges and coatings.

Bear Mountain's Bear Grip Self-Locking Posts have revolutionized the method fencing materials are installed by eliminating the need to use mechanical fasteners.

### BEAR GRIP SELF-LOCKING POST WITH SOLAR LIGHT POST CAP

Bear Mountain's Specially designed post systems provide a self-locking mechanism to connect panel to post without having to use any mechanical fasteners. Bear's Solar Light Post Cap and Posts can integrate site illumination without having to install any electrical infrastructure

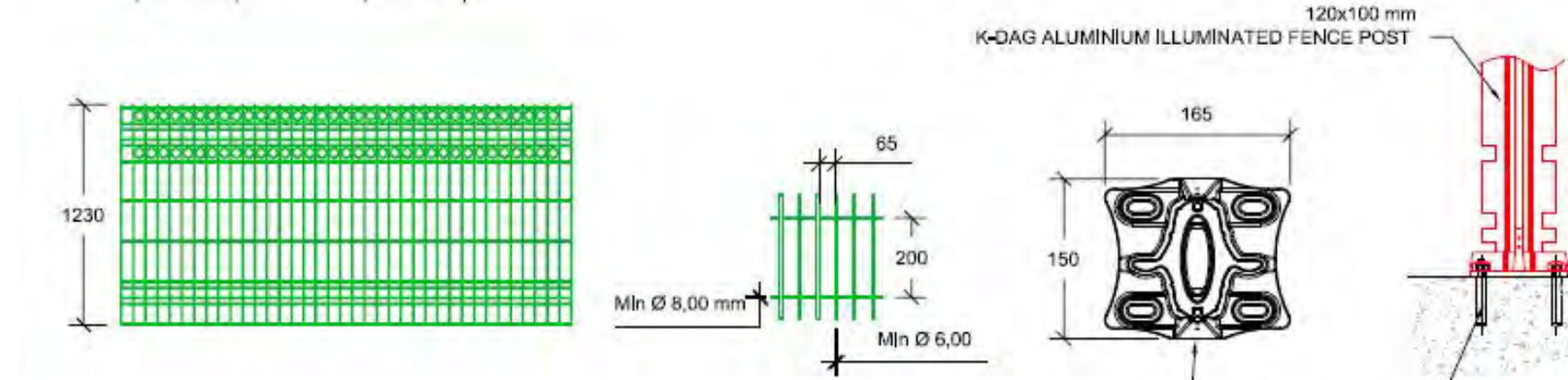
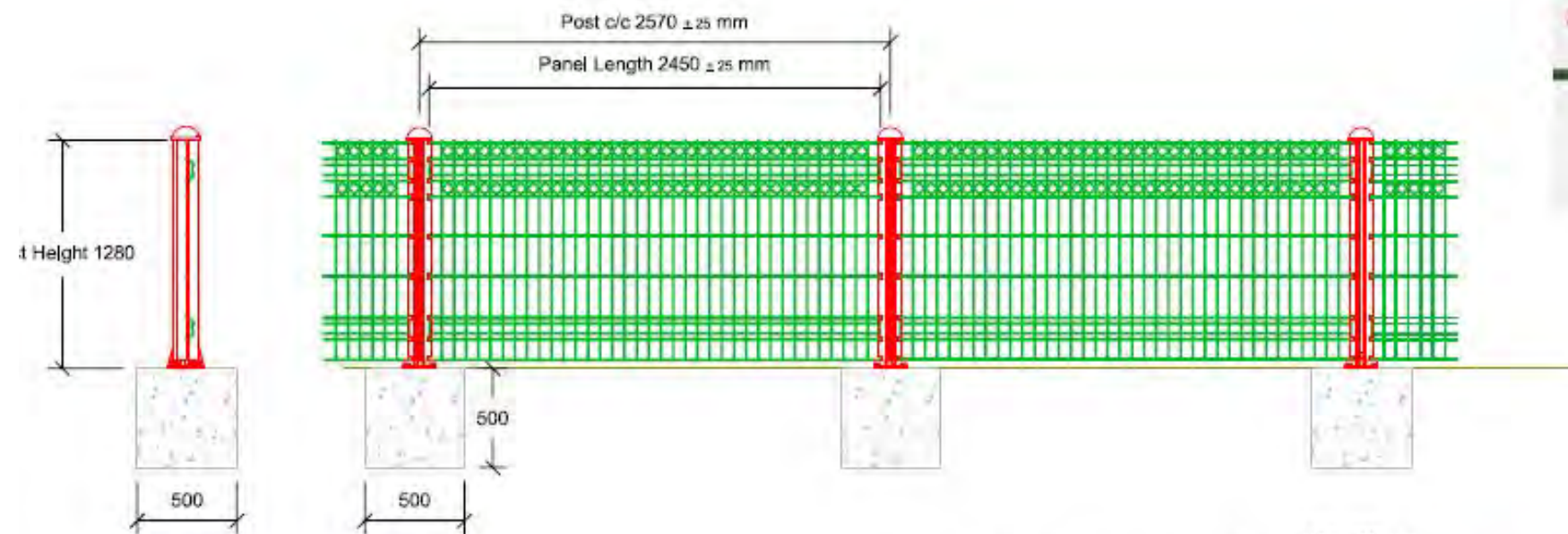





## **BEAR GRILLE DECO MESH FENCING SYSTEM**



# DECO WAVE MESH FENCING SYSTEM



**CUSTOM SOLUTIONS**  
 BEAR MOUNTAIN'S DESIGN  
 TEAM PROVIDE CUSTOMIZED  
 DESIGN SOLUTIONS TO MEET  
 YOUR DESIGN AND SITE  
 REQUIREMENTS

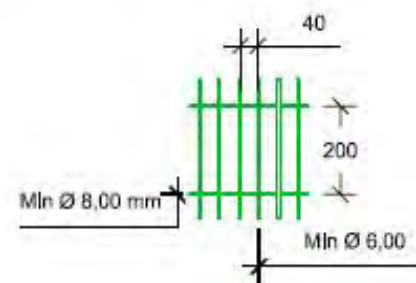
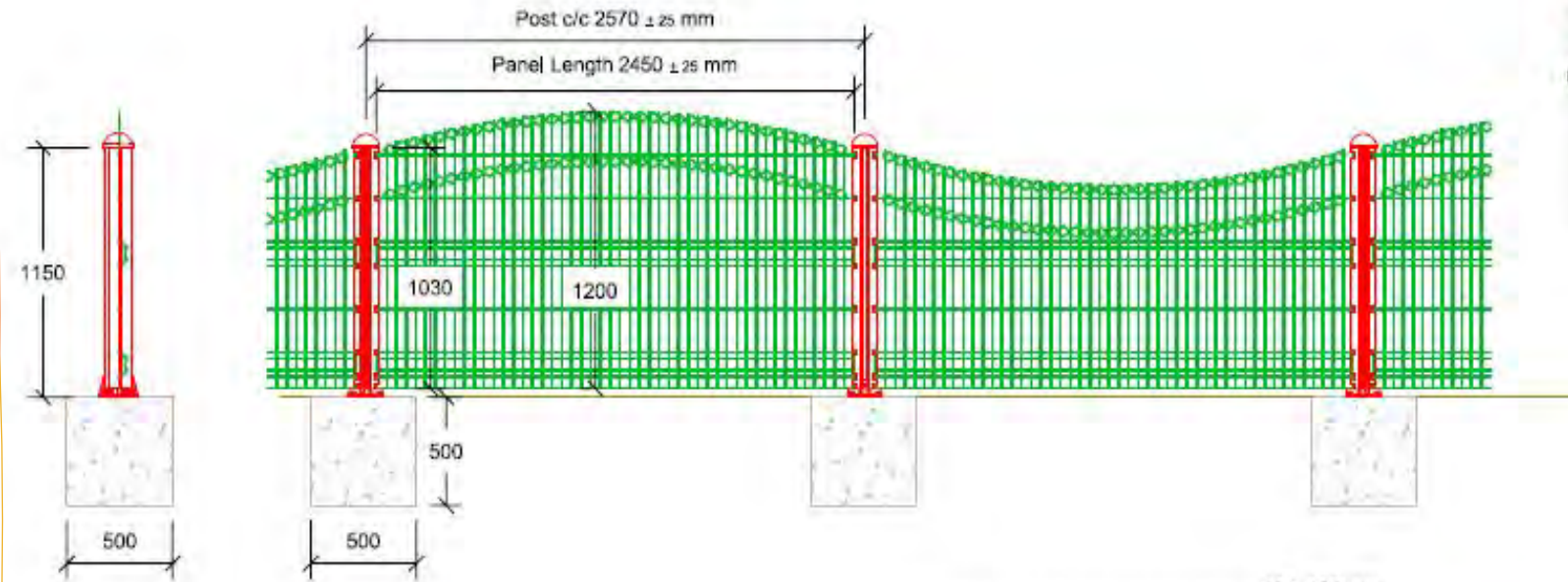

120x100 mm  
 K-DAG ALUMINIUM ILLUMINATED FENCE POST

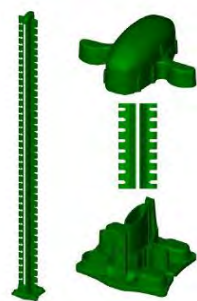
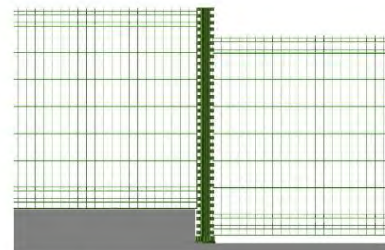
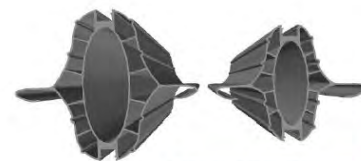
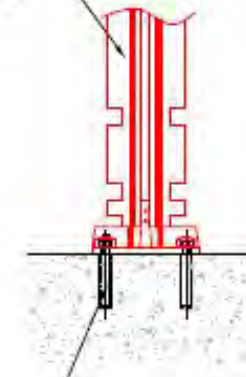
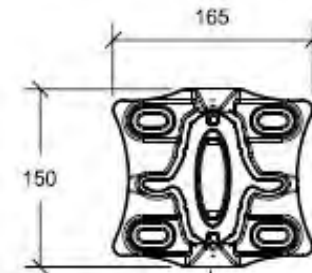

BEAR GRIP POST  
 WITH SOLAR LIGHT  
 POST CAP AND SOLAR  
 LIGHT LED STRIP  
 ILLUMINATES THE  
 ENTIRE LENGTH OF  
 THE BEAR GRIP POST  
 AS WELL AS THE TOP  
 OF THE POST. THE  
 LOCKING  
 MECHANISM ALLOWS  
 FOR THE EASY  
 TRANSITION OF  
 PANEL HEIGHTS FOR  
 SLOPY TERRAINS  
 WITH GRADIENT  
 CHANGES.



**3D MODELING AND  
 DESIGN**  
 REACH OUT TO OUR  
 CONSULTANTS TODAY TO  
 VIEW OUR 3D DESIGN AND  
 MODELING TECHNOLOGY



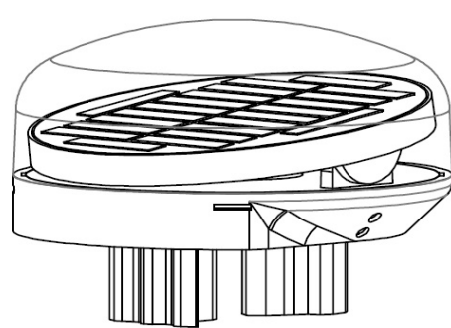
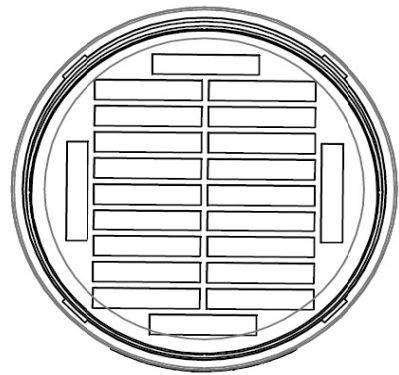
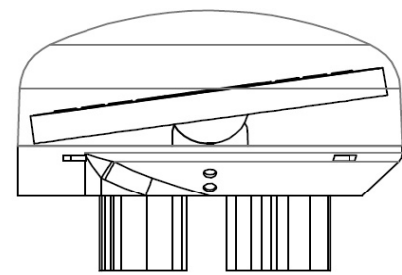
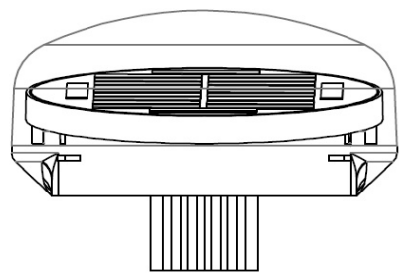

SOLAR LIGHT POST CAPS PROVIDE ILLUMINATION TO THE FENCE LINE. RENEWABLE ENERGY SOURCE BEING UTILIZED TO OPTIMIZE YOUR SITE'S SECURITY AND APPEARANCE.

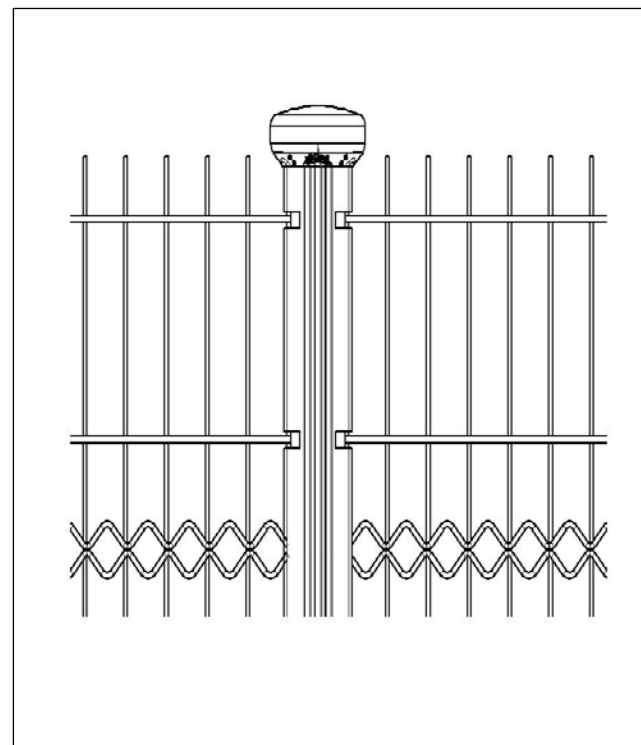

SPECIALLY DESIGNED NOTCHES IN THE BEAR GRIP POST LOCK EVERY HORIZONTAL AND VERTICAL LINE WIRE ALONG THE PANEL EDGE INTO PLACE PROVIDING A STRONG AND SECURE FIXING POINT.

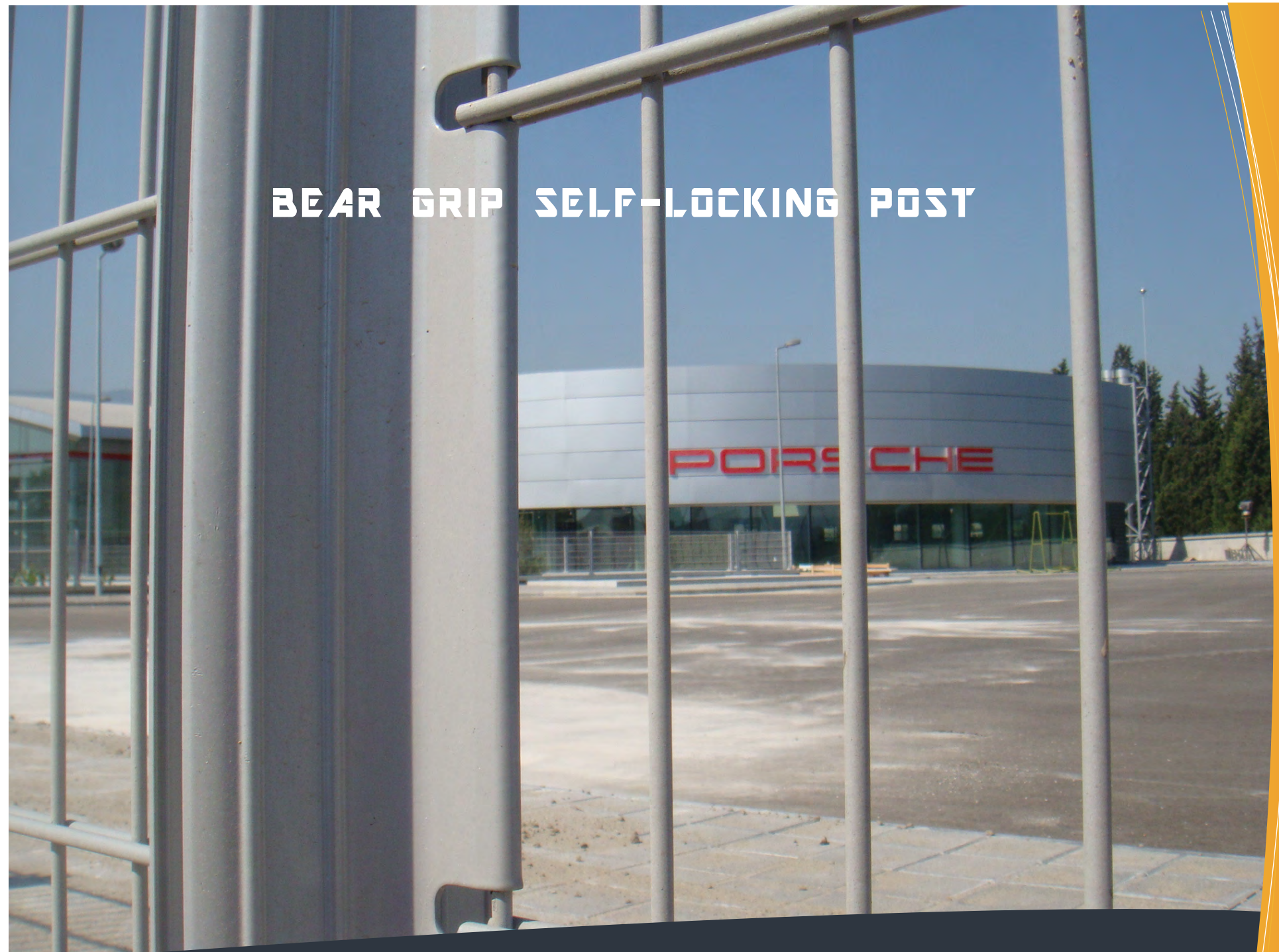

BEAR MOUNTAIN **SELF-LOCKING POST** ELIMINATING THE NEED TO USE MECHANICAL FASTENERS

ANTI-VANDAL  
SECURE LOCKING  
MECHANISM



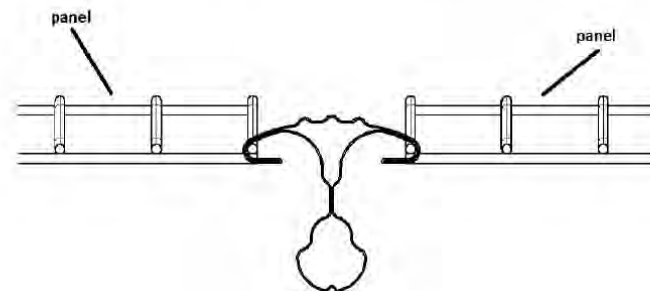
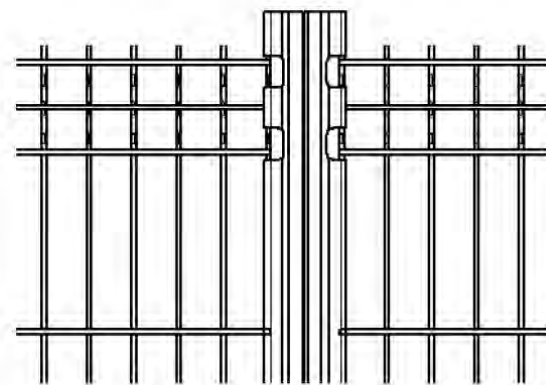
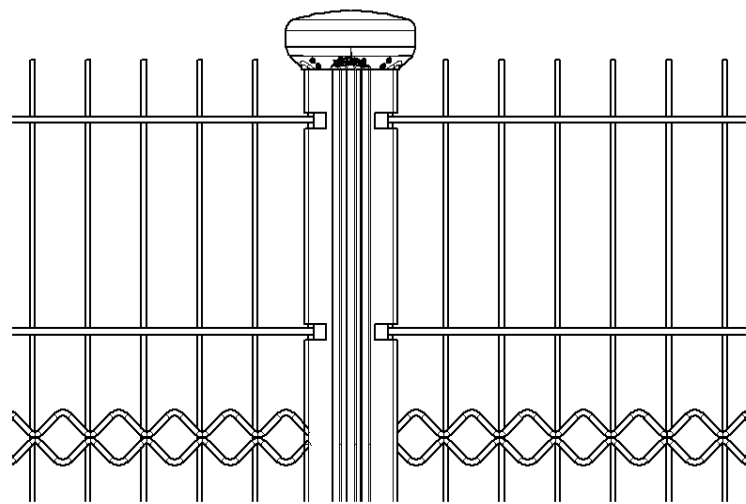

BEAR GRIP SELF-LOCK POST WITH SOLAR LIGHT POST CAP

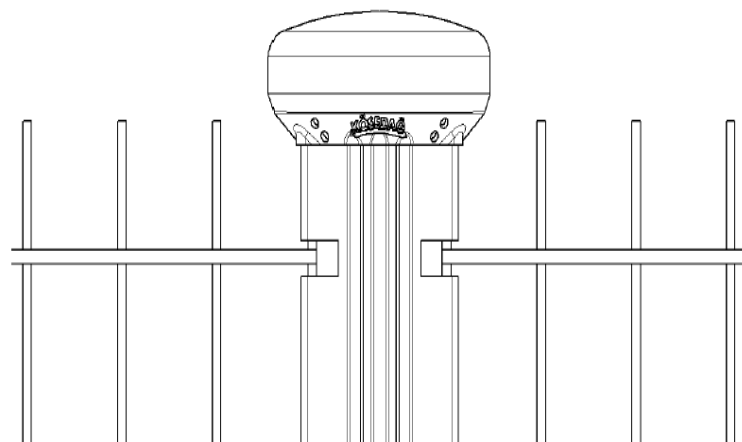

- The specially designed Steel Bear Grip Self-Locking Post features a 3 post type design which increases the rigidity and provides a pleasing finish to the fence line.

- Due to the double layer Steel Rolling process of the Bear Grip Post, the material strength properties are increased whilst maintaining an economic advantage.

- The Bear Grip Self-Locking Post has eliminated the conventional production methods of cutting, welding, clamping and the need to use mechanical fasteners.

- Preventing the risk of coating damage during installation as it is free of accessories such as screws, bolts, clips or clamps.

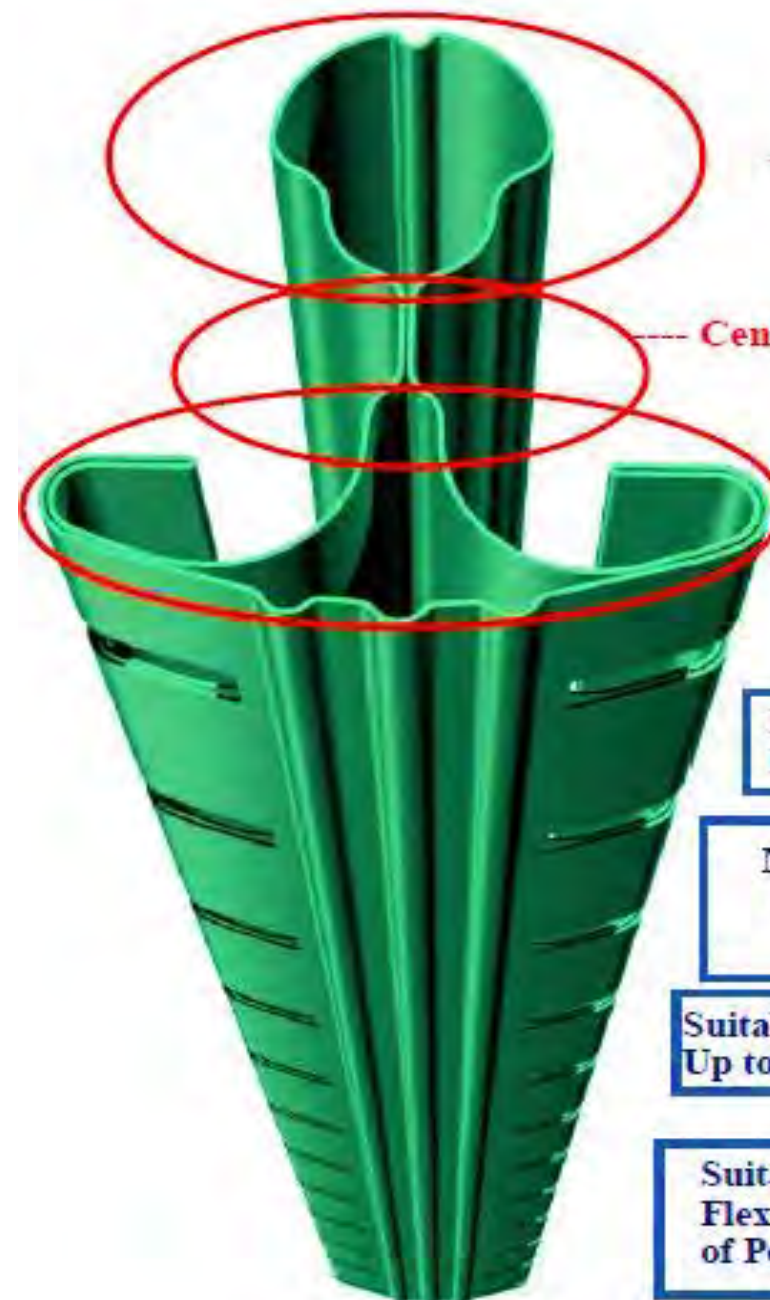
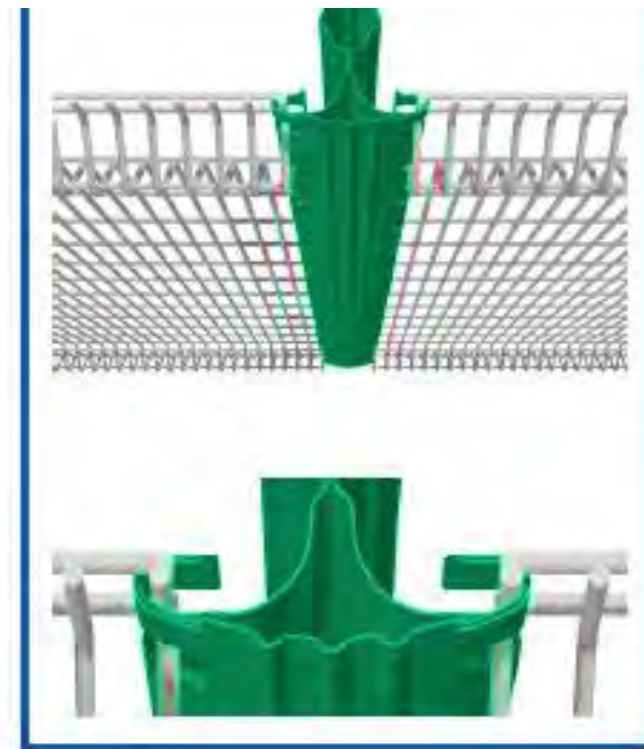

--- Back Section

--- Central Section

--- Front Section

High rigidity due to unique Design. (Tripple section)

No drilling or welding is Required.

No fitting required due to side fixation (self-locking)

Suitable for corner applications Up to 135°

Suitable for sloppy terrain due to Flexibility attributed to side notches of Post

Side view

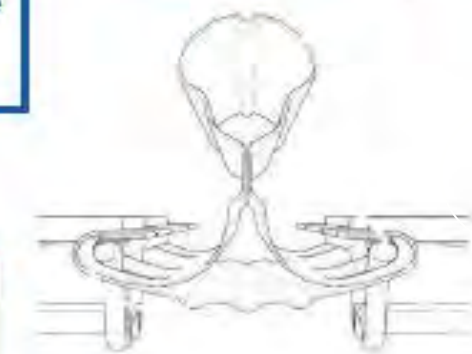



## **Bear Grille Forest & Park Mesh Fence**

*Bear Grille Forest & Park Land Fencing system is the ideal solution for any fencing project that requires superior quality finishes at the most competitive rates available on the market.*

The Bear Grille Forest & Park Mesh Fence System is the ideal substitute to chain link and woven fencing materials. Bear Mountain's competitive rates and hardware free assembly methods make our Products a far more cost-effective range of solutions as well as a far more attractive offering. Bear Grille Forest & Park Mesh Fence can be provided in a range of wire gauges, finishes as well as panel pressing designs. This is the ideal solution for public spaces, city-scapes, gated communities, golf courses and speedways. This fencing solution is a versatile, high quality and long-lasting solution that can be used to demarcate almost any site...



**BEAR GRILLE FOREST & PARK FENCE SYSTEM  
THE IDEAL ALTERNATE TO CHAIN LINK AND  
PICKET FENCING MATERIALS**



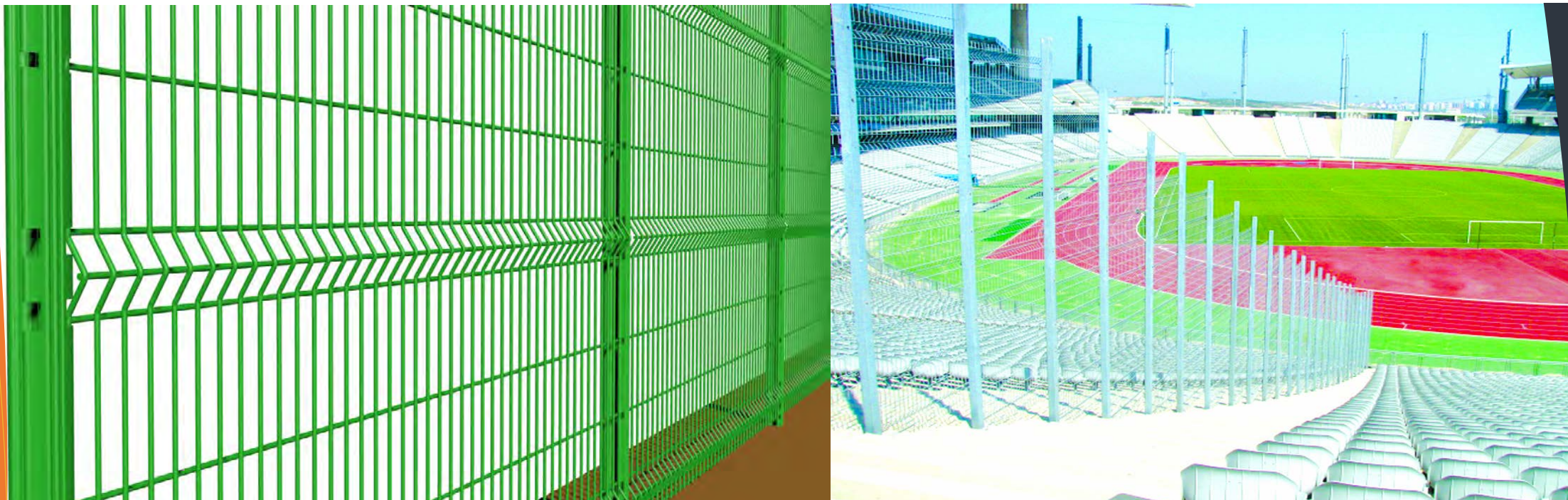

## BEAR GRIP SELF-LOCKING POST 40% MATERIALS AND INSTALLATION SAVINGS

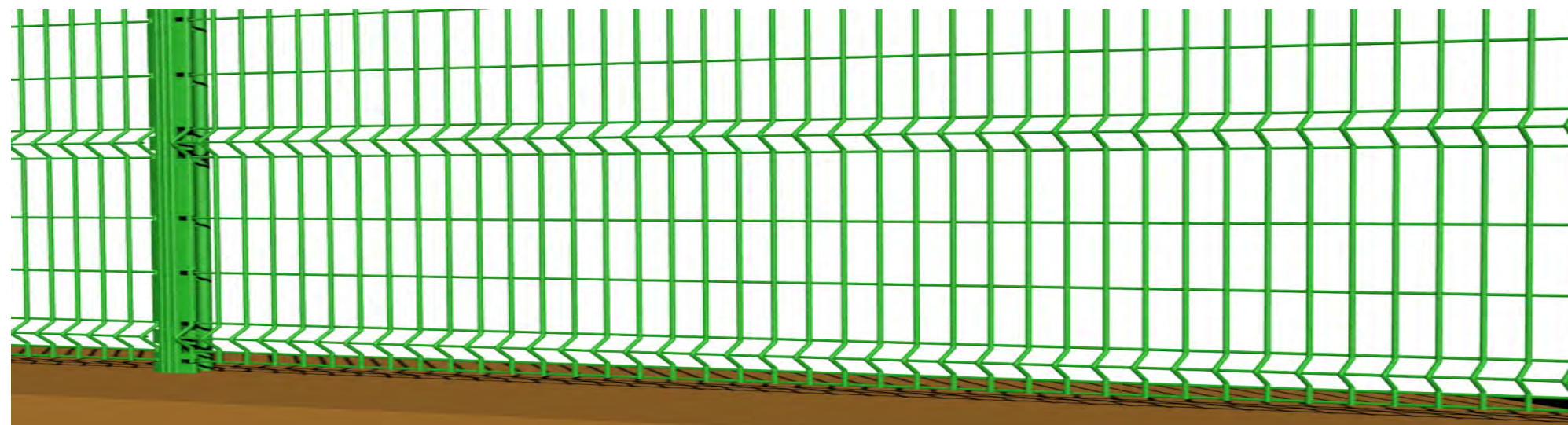
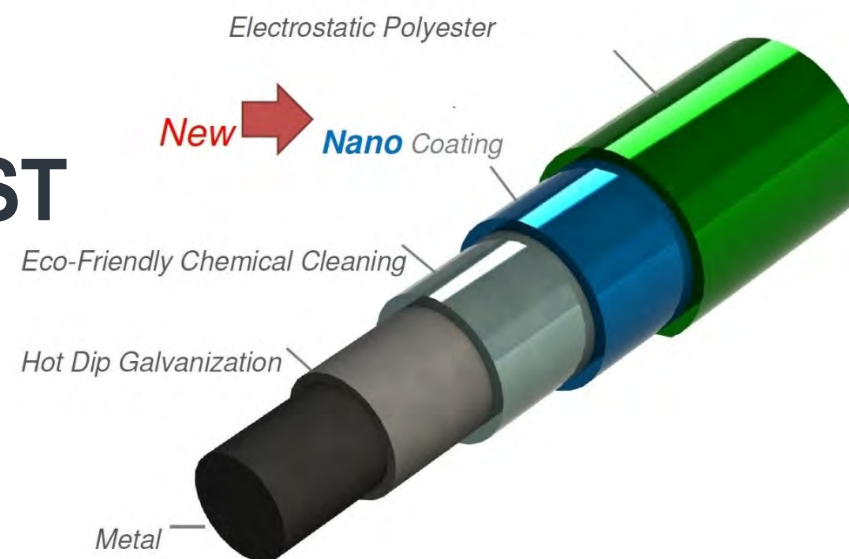

### NANO+ELECTROSTATIC POLYESTER COATING

Bear Mountain's Nano + Electrostatic Polyester Metal Coating is a peel and flake resistant quartz coating specifically designed for Bear Mountain's range of fencing products. It is designed to protect metal surfaces from normal destructive forces, and provides a long-lasting barrier of superior resistance to rust, moisture, corrosion, salt spray, acid rain, UV damage, oxidation, galvanic corrosion, animal & bird waste damage, and reduces ice adhesion.



# BEAR SCAPE LEAF ARCHITECTURAL GREEN SCREEN

## BEAR SCAPE LEAF ARCHITECTURAL GREEN SCREEN & FENCING

Bear Scape Leaf Fence is the ideal architectural solution for city landscaping projects and for building facades. The Bear Scape Leaf Fence can be installed on city buildings, inside Hotel interiors and facilities, in and around Shopping Center Buildings and even on the facades of Highway Infrastructure. The Bear Scape Leaf Fence creates a natural beauty and seamlessly connects the built environment to the natural environment.



BEAUTIFY YOUR FACILITY, FAÇADE OR ROOFTOPS WITH BEAR SCAPE GREEN SCREEN SOLUTIONS AND FENCING PRODUCTS





**BEAR MOUNTAIN SECURITY**  
SECURITY | DESIGN | INNOVATION

*Founded in Washington, D.C*

**BEAR MOUNTAIN SECURITY**

SECURITY | DESIGN | INNOVATION

*Maryland | Washington D.C. | Virginia | Email: [info@BearMountainSecurity.com](mailto:info@BearMountainSecurity.com)*

[www.BearMountainSecurity.com](http://www.BearMountainSecurity.com)

**TEL: 202.549.3431**